

ORIGINAL INSTRUCTIONS

FEIDER

MACHINES

DRYWALL SANDER

FPG710-SH

Instruction manual



WARNING: Read the instruction manual thoroughly before using this tool.

BUILDER SAS
ZI - 32, RUE ARISTIDE BERGES, 31270 CUGNAUX, FRANCE





Caution-Read the operating instructions to reduce the risk of injury



Wear ear-muffs

The impact of noise can cause damage to hearing



Wear a breathing mask

Dust which is injurious to health can be generated when working on wood and other materials. Never use the device to work on any materials containing asbestos!



Wear safety goggles

Sparks generated during working or splinters, chips and dust emitted by the device can cause loss of sight.



Important !

When using equipment, a few safety precautions must be observed to avoid injuries and damage. Please read the complete operating manual carefully. Keep this manual in a safe place, so that the information is available at all times. If you give the equipment to any other person, give them these operating instructions as well.

We accept no liability for damage or accidents which arise due to non-observance of these instructions and the safety information.

1. SAFETY INSTRUCTIONS

1.1 General Power Tool Safety Warnings



WARNING Read all safety warnings and all instructions. *Failure to follow the warnings and instructions may result in electric shock, fire and/or serious injury.*

Save all warnings and instructions for future reference.

The term "power tool" in the warnings refers to your mains-operated (corded) power tool or battery-operated (cordless) power tool.

1) Work area safety

- a. **Keep work area clean and well lit.** *Cluttered or dark areas invite accidents.*
- b. **Do not operate power tools in explosive atmospheres, such as in the presence of flammable liquids, gases or dust.** *Power tools create sparks which may ignite the dust or fumes.*
- c. **Keep children and bystanders away while operating a power tool.** *Distractions can cause you to lose control.*

2) Electrical safety

- a) **Power tool plugs must match the outlet. Never modify the plug in any way. Do not use any adapter plugs with earthed (grounded) power tools.** *Unmodified plugs and matching outlets will reduce risk of electric shock.*
- b) **Avoid body contact with earthed or grounded surfaces, such as pipes, radiators, ranges and refrigerators.** *There is an increased risk of electric shock if your body is earthed or grounded.*
- c) **Do not expose power tools to rain or wet conditions.** *Water entering a power tool will increase the risk of electric shock.*

- d) **Do not abuse the cord. Never use the cord for carrying, pulling or unplugging the power tool. Keep cord away from heat, oil, sharp edges or moving parts.** *Damaged or entangled cords increase the risk of electric shock.*
- e) **When operating a power tool outdoors, use an extension cord suitable for outdoor use.** *Use of a cord suitable for outdoor use reduces the risk of electric shock.*
- f) **If operating a power tool in a damp location is unavoidable, use a residual current device (RCD) protected supply.** *Use of an RCD reduces the risk of electric shock.*

3) Personal safety

- a) **Stay alert, watch what you are doing and use common sense when operating a power tool. Do not use a power tool while you are tired or under the influence of drugs, alcohol or medication.** *A moment of inattention while operating power tools may result in serious personal injury.*
- b) **Use personal protective equipment. Always wear eye protection.** *Protective equipment such as dust mask, non-skid safety shoes, hard hat, or hearing protection used for appropriate conditions will reduce personal injuries.*
- c) **Prevent unintentional starting. Ensure the switch is in the off-position before connecting to power source and/or battery pack, picking up or carrying the tool.** *Carrying power tools with your finger on the switch or energising power tools that have the switch on invites accidents.*
- d) **Remove any adjusting key or wrench before turning the power tool on.** *A wrench or a key left attached to a rotating part of the power tool may result in personal injury.*
- e) **Do not overreach. Keep proper footing and balance at all times.** *This enables better control of the power tool in unexpected situations.*
- f) **Dress properly. Do not wear loose clothing or jewellery. Keep your hair, clothing and gloves away from moving parts.** *Loose clothes, jewellery or long hair can be caught in moving parts.*
- g) **If devices are provided for the connection of dust extraction and collection facilities, ensure these are connected and properly used.** *Use of dust collection can reduce dust-related hazards.*

4) Power tool use and care

- a) **Do not force the power tool. Use the correct power tool for your application.** *The correct power tool will do the job better and safer at the rate for which it was designed.*

- b) **Do not use the power tool if the switch does not turn it on and off.** *Any power tool that cannot be controlled with the switch is dangerous and must be repaired.*
- c) **Disconnect the plug from the power source and/or the battery pack from the power tool before making any adjustments, changing accessories, or storing power tools.** *Such preventive safety measures reduce the risk of starting the power tool accidentally.*
- d) **Store idle power tools out of the reach of children and do not allow persons unfamiliar with the power tool or these instructions to operate the power tool.** *Power tools are dangerous in the hands of untrained users.*
- e) **Maintain power tools. Check for misalignment or binding of moving parts, breakage of parts and any other condition that may affect the power tool's operation. If damaged, have the power tool repaired before use.** *Many accidents are caused by poorly maintained power tools.*
- f) **Keep cutting tools sharp and clean.** *Properly maintained cutting tools with sharp cutting edges are less likely to bind and are easier to control.*
- g) **Use the power tool, accessories and tool bits etc. in accordance with these instructions, taking into account the working conditions and the work to be performed. Use of the power tool for operations different from those intended could result in a hazardous situation.**

5) Service

- a) **Have your power tool serviced by a qualified repair person using only identical replacement parts.** *This will ensure that the safety of the power tool is maintained.*

1.2. Safety warnings for scouring machines

- a) **This power tool is intended to function as a scouring machine (electrical sander). Read all safety warnings, instructions, illustrations and specifications provided with this power tool.** *Failure to follow all instructions listed below may result in electric shock, fire and/or serious injury.*
- b) **Operations such as grinding, wire brushing, polishing or cutting-off are not recommended to be performed with this power tool. Operations for which the power tool was not designed may create a hazard and cause personal injury.**

- c) **Do not use accessories which are not specifically designed and recommended by the tool manufacturer.** *Just because the accessory can be attached to your power tool, it does not assure safe operation.*
- d) **The rated speed of the accessory must be at least equal to the maximum speed marked on the power tool.** *Accessories running faster than their rated speed can break and fly apart.*
- e) **The outside diameter and the thickness of your accessory must be within the capacity rating of your power tool.** *Incorrectly sized accessories cannot be adequately guarded or controlled.*
- f) **Threaded mounting of accessories must match the grinder spindle thread. For accessories mounted by flanges, the arbour hole of the accessory must fit the locating diameter of the flange.** *Accessories that do not match the mounting hardware of the power tool will run out of balance, vibrate excessively and may cause loss of control.*
- g) **Do not use a damaged accessory. Before each use inspect the accessory such as abrasive wheels for chips and cracks, backing pad for cracks, tear or excess wear, wire brush for loose or cracked wires. If power tool or accessory is dropped, inspect for damage or install an undamaged accessory. After inspecting and installing an accessory, position yourself and bystanders away from the plane of the rotating accessory and run the power tool at maximum no-load speed for one minute.** *Damaged accessories will normally break apart during this test time.*
- h) **Wear personal protective equipment. Depending on application, use face shield, safety goggles or safety glasses. As appropriate, wear dust mask, hearing protectors, gloves and workshop apron capable of stopping small abrasive or workpiece fragments.** *The eye protection must be capable of stopping flying debris generated by various operations. The dust mask or respirator must be capable of filtering particles generated by your operation. Prolonged exposure to high intensity noise may cause hearing loss.*
- i) **Keep bystanders a safe distance away from work area. Anyone entering the work area must wear personal protective equipment.** *Fragments of workpiece or of a broken accessory may fly away and cause injury beyond immediate area of operation.*
- j) **Hold the power tool by insulated gripping surfaces only, when performing an operation where the cutting accessory may contact hidden wiring or its own cord.** *Cutting accessory contacting a "live" wire may make exposed metal parts of the power tool "live" and could give the operator an electric shock.*

- k) **Position the cord clear of the spinning accessory.** *If you lose control, the cord may be cut or snagged and your hand or arm may be pulled into the spinning accessory.*
- l) **Never lay the power tool down until the accessory has come to a complete stop.** *The spinning accessory may grab the surface and pull the power tool out of your control.*
- m) **Do not run the power tool while carrying it at your side.** *Accidental contact with the spinning accessory could snag your clothing, pulling the accessory into your body.*
- n) **Regularly clean the power tool's air vents.** *The motor's fan will draw the dust inside the housing and excessive accumulation of powdered metal may cause electrical hazards.*
- o) **Do not operate the power tool near flammable materials.** *Sparks could ignite these materials.*
- p) **Do not use accessories that require liquid coolants.** *Using water or other liquid coolants may result in electrocution or shock.*

1.3 Further safety instructions

Kickback and Related Warnings

Kickback is a sudden reaction to a pinched or snagged rotating wheel, backing pad, brush or any other accessory. Pinching or snagging causes rapid stalling of the rotating accessory which in turn causes the uncontrolled power tool to be forced in the direction opposite of the accessory's rotation at the point of the binding.

For example, if an abrasive wheel is snagged or pinched by the workpiece, the edge of the wheel that is entering into the pinch point can dig into the surface of the material causing the wheel to climb out or kick out. The wheel may either jump toward or away from the operator, depending on direction of the wheel's movement at the point of pinching. Abrasive wheels may also break under these conditions.

Kickback is the result of power tool misuse and/or incorrect operating procedures or conditions and can be avoided by taking proper precautions as given below.

- a. **Maintain a firm grip on the power tool and position your body and arm to allow you to resist kickback forces. Always use auxiliary handle, if provided, for maximum control over kickback or torque reaction during start-up.** *The operator can control torque reactions or kickback forces, if proper precautions are taken.*







- b. **Never place your hand near the rotating accessory.** *Accessory may kickback over your hand.*
- c. **Do not position your body in the area where power tool will move if kickback occurs.** *Kickback will propel the tool in direction opposite to the wheel's movement at the point of snagging.*
- d. **Use special care when working corners, sharp edges etc. Avoid bouncing and snagging the accessory.** *Corners, sharp edges or bouncing have a tendency to snag the rotating accessory and cause loss of control or kickback.*
- e. **Do not attach a saw chain woodcarving blade or toothed saw blade.** *Such blades create frequent kickback and loss of control.*

Additional safety instructions for sanding operations

Safety warnings specific to sanding operations

- a) **Do not use abrasive paper that is too oversized for the sanding discs.** *Follow the recommendations of the manufacturers, when choosing the sandpaper. Larger sandpaper extending beyond the sanding pad presents a laceration hazard and may cause snagging, tearing of the disc, or kickback.*

Warning symbol

	WARNING - To reduce the risk of injury, user must read instruction manual.
	Always wear ear protection.
	Always wear goggles.
	Always wear a breathing mask.
	In accordance with essential applicable safety standards of European directives.
	Class II product.

Residual risks

Even if you use this product in accordance with all safety requirements, the potential risks of injury and damage remain. The following risks may arise in the structure and design of this product. Always be vigilant when using this product, so you can recognize and manage the risks rather.

There are harmful health consequences resulting from the emission of vibrations if the product is used for long periods or is not properly managed and properly maintained.

There is a risk of injury about the emission of dust and potential debris.
Risk of injuries to persons and their property due to flying objects

Harmful/toxic dust can arise from sanding (e.g. lead painted surfaces, woods, etc.). Contact with or inhalation of these dusts can endanger the health of operator and bystanders. When using this tool, always wear personal protective equipment, specifically a dust mask protection. When operating the tool, take a position where you will not be in contact with these dusts.

Intended use

The drywall sander is designed for sanding walls and ceilings made of drywall or plaster. The sander provides superior finish and is faster than conventional finishing methods for both new construction and renovation work. Clean-up time is minimized by using an external vacuum cleaner attached to the sander.

Wear hearing protection!

2. Your tool

Description

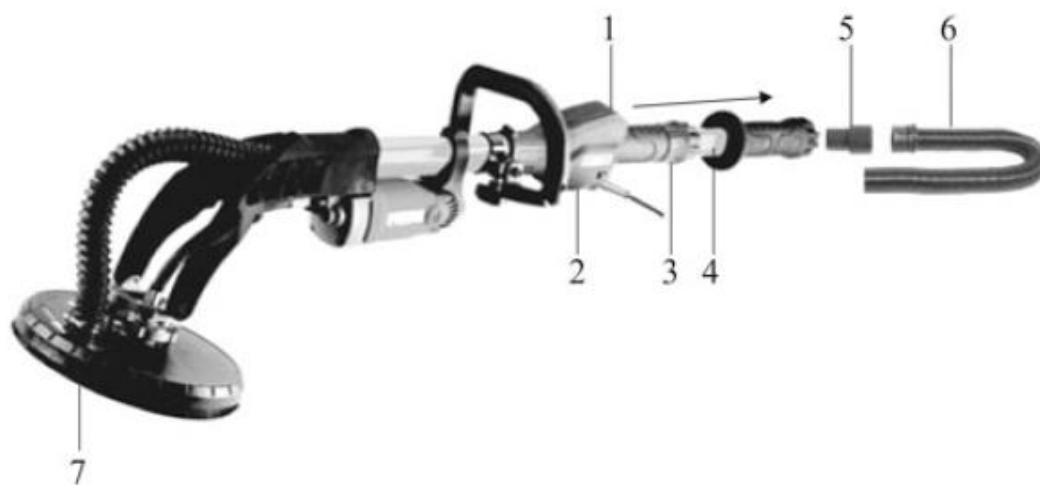

- 1 On/off switch
- 2 Speed regulation
- 3 Lock for telescopic length extension
- 4 Telescopic length extension
- 5 Dust extraction holder
- 6 Dust extraction hose
- 7 Sanding/grinding disk

Items supplied

- Drywall Power Sander
- 6 X Abrasive paper
- Flexible soft hose

- 1set carbon brushes
- 1 Screwdriver
- 6X clasp ring
- 1 hexagon spanner
- 1 handle

Technical data

Voltage/Frequency: 230-240V~ /50Hz

Power input: 710W

No load speed: 1000-2200rpm

Abrasive pad: 215mm

Sanding paper: 225mm

Protection class: II/□

Weight: 4.8kg

Sound and vibration

Sound pressure level LpA :79.9 d B (A) , K pA : 3 d B (A)

Sound power level LwA: 90.9 d B (A) , K wA :3dB (A)

The impact of noise can cause damage to hearing.

Overall oscillation value determined according to EN 60745

Vibration emission value ah, DS=2,254m/s²,Uncertainty K = 1,5 m/s²



Caution

The vibration value changes according to the area of application of the electric tool and may exceed the specified value in exceptional circumstances.

The declared vibration value was measured according to the method described in a standard and can be used for comparison. The declared vibration value can also be used in a preliminary exposure assessment.

The vibration emission during actual use of the power tool depends on how it is used and may differ from the total value shown. The safety measures necessary to protect the operator should be identified based on an estimate of exposure under actual conditions of use (taking into account all phases of the duty cycle, such as when The appliance is off, when it is running empty, and when it is charging.

Keep the noise emissions and vibrations to a minimum.

- Only use appliances which are in perfect working order.
- Service and clean the appliance regularly.
- Adapt your working style to suit the appliance.
- Do not overload the appliance.
- Have the appliance serviced whenever necessary.
- Switch the appliance off when it is not in us.
- Wear protective gloves.

3. OPERATING INSTRUCTIONS

3.1 Before starting the appliance

Before you connect the appliance to the mains supply make sure that the data on the rating plate are identical to the mains data.

Always pull the power plug before making adjustments to the appliance.

3.1.1 Changing the abrasive paper

The sanding/polishing disk comes with a Velcro fastening system for sanding/polishing paper to be attached without a clamping device.

Before you attach a new piece of sanding/polishing paper, knock out any dirt from the Velcro fastener and clean with a brush or, if necessary, with compressed air.

Place the sanding/polishing paper on the sanding/polishing disk. Fix the sanding/polishing paper in place by pressing it firmly with your hand.



3.1.2 Fitting the dust extraction system

The dust extraction system prevents the accumulation of dirt and high dust loads in the air, and it makes it easier to dispose of the dust.

- Connect the hose (1) on both ends with the connectors (2+3), at which point, the hose must click-in to the connectors (see "Connection Piece").
- The thinner connection piece (2) should now be connected to the handle (4).
- To dismantle the hose, carefully press into the notches with the flat side of the enclosed screwdriver. By doing this, the interlocking lugs are released from the notches and the hose can be taken back out of the mount.
- Connect your appliance to an extraction unit or vacuum cleaner. This will provide excellent extraction of chips and dust from the workpiece.

Advantages: The advantages are that you will protect both the appliance and your own health. Your work area will also be clean and safe.

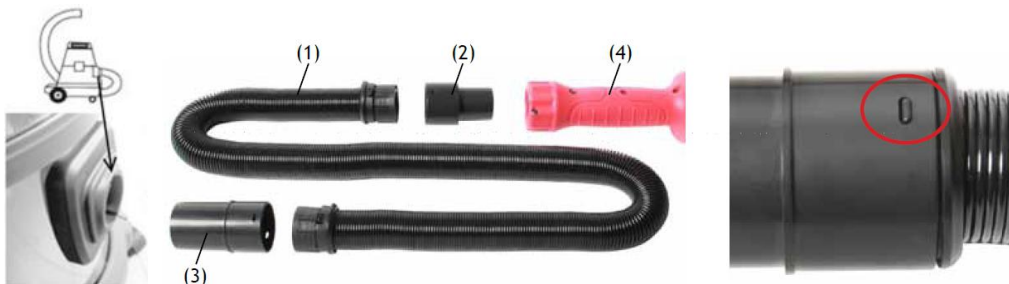

Suction Hose Connection

Connection Piece

3.2 Starting up

3.2.1 ON/OFF switch

To switch on the appliance set the ON/OFF switch(1) to position 1.

Move the ON/OFF switch (1) to position 0 to switch off the appliance.

3.2.2 Speed controller

To pre-select the speed turn the knurled screw (2) on the switch.



Plus direction: Higher speed

Minus direction: Lower speed

3.2.3 Using the telescopic length extension

Unscrew the lock for the telescopic length extension (3) approx.2-3 turns (Now the telescopic length extension(4) can be pulled out.



3.3 Replacing the power cable

If the power cable for this appliance is damaged, it must be replaced by the manufacturer or its after-sales service or similarly trained personal to avoid danger.

3.4 Cleaning, maintenance and ordering of spare parts

Always pull out the mains power plug before starting any cleaning work.

3.4.1 Cleaning

- Keep all safety devices, air vents and the motor housing free of dirt and dust as far as possible. Wipe the appliance with a clean cloth or blast it with compressed air at low pressure.
- We recommend that you clean the appliance immediately after you use it.
- Clean the appliance regularly with a damp cloth and some soft soap. Do not use cleaning agents or solvents; these may be aggressive to the plastic parts in the appliance. Ensure that no water can get into the interior of the appliance.

3.4.2 Carbon brushes

In case of excessive sparking, have the carbon brushes checked only by a qualified electrician. Caution: The carbon brushes should not be replaced by anyone but a qualified electrician.

3.4.3 Servicing

There are no parts inside the appliance which require additional maintenance.

3.4.4 Ordering replacement parts:

Please provide the following information on all orders for spare parts:

- Model/type of the appliance
- Article number of the appliance
- ID number of the appliance
- Spare part number of the required spare part

3.4.5 Changing the brush ring

Loosen the six screws with a screwdriver.

Lift the brush ring carefully out with the screwdriver. To assemble the new brush ring proceed in reverse order.



3.4.6 Changing the sanding disc

- If the velcro fastening is worn out, the sanding-disc must be changed.
- Before changing the sanding-disc pull the plug from the outlet.
- Remove the sandpaper from the sanding-disc
- Unscrew the sanding-disc from the threaded connection.
- Remove the sanding-disc
- Place the new sanding-disc on the machine
- Put in tightly.



3.4.7 Delivered with harness

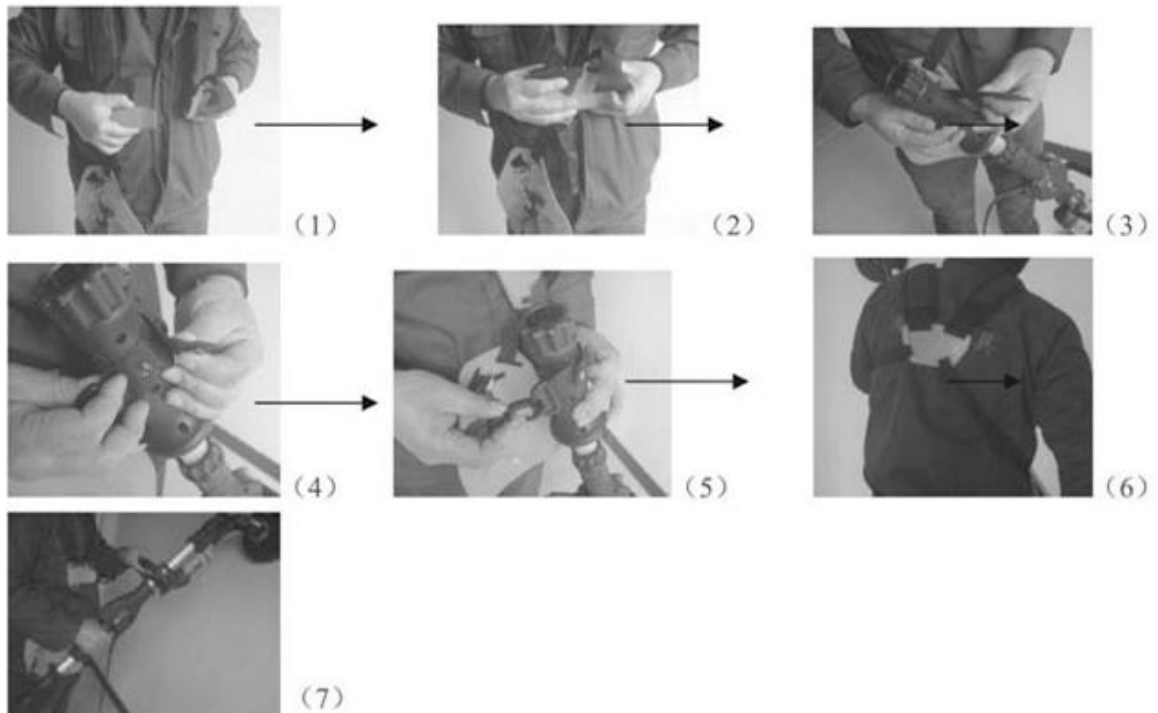

3.4.8 Correct method of use

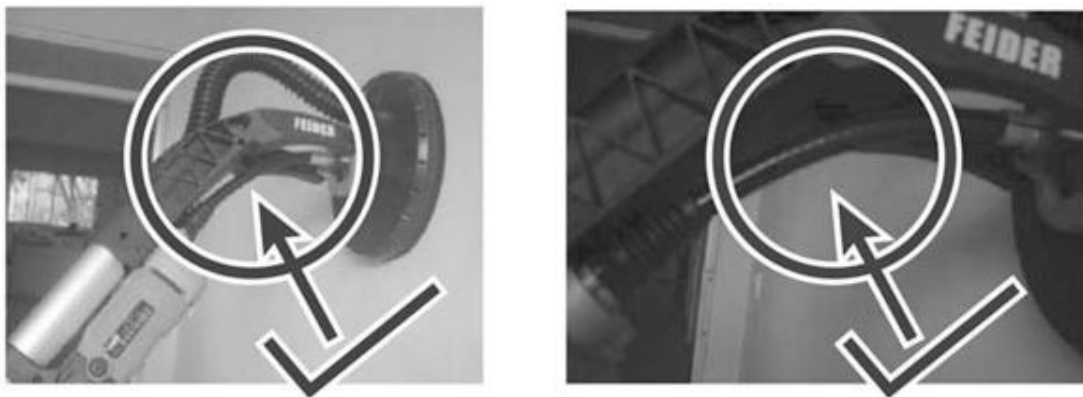

Error working method

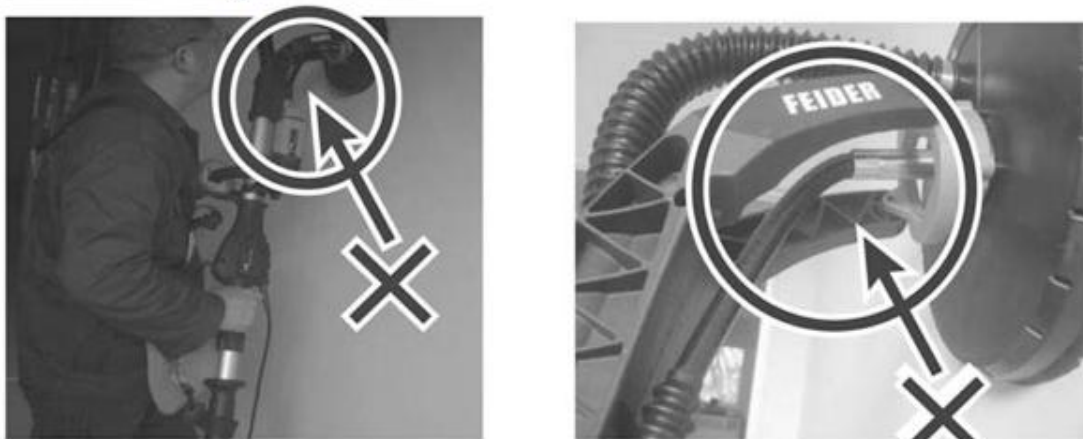

3.5 Sanding head mounting

Make sure the opening in the plastic cover is facing up (as indicated by the arrow), place the yellow driveshaft into the hole in the aluminum assembly, then turn clockwise to tighten.

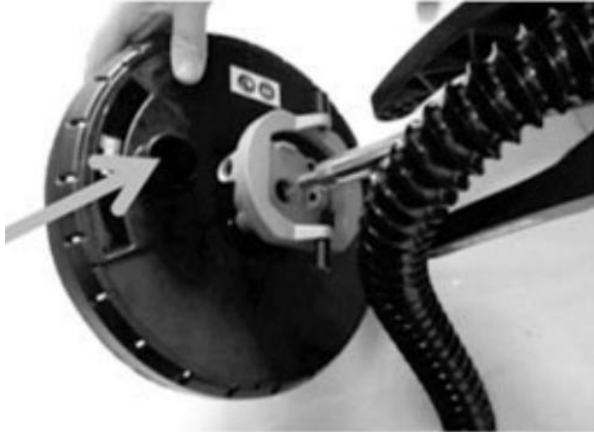

Remove one of the black screws from the aluminum assembly, match the hole in the black support arm with the hole from which you removed the screw, and then insert the screw into the hole in the support arm (as shown on the arrows).



Retirez l'une des vis noires de l'assemblage en aluminium, faites correspondre le trou du bras de support noir avec le trou duquel vous avez retiré la vis, puis insérez la vis dans le trou du bras de support (comme indiqué sur les flèches)



Feed the black screw through the support arm and aluminum assembly, and tighten securely with a flat screwdriver.
Place the clamp of the dust vacuum hose into the opening of the plastic cover and tighten the clamp screw firmly with a flat screwdriver.

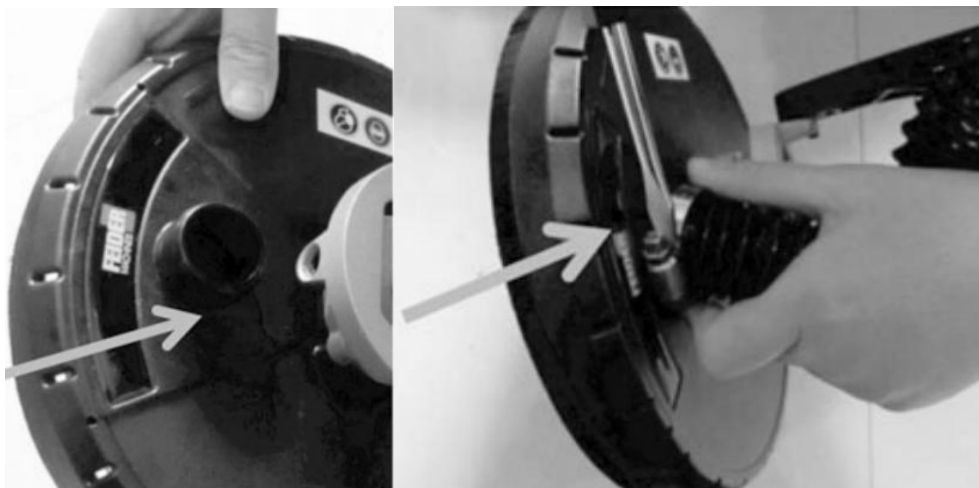

Assembly completed



4. Disposal and recycling

The appliance is supplied in packaging to prevent its being damaged in transit. This packaging is raw material and can therefore be reused or can be returned to the raw material system.

The appliance and its accessories are made of various types of material, such as metal and plastic. Defective components must be disposed of as special waste. Ask your dealer or your local council.

5. Use and maintenance of the tool

a) Do not force the tool. Use the right tool for your application. The adapted tool will do all the work and more safely at the speed for which it was built

b) Do not use the Tool if the switch does not switch from on to off.

Any tool that cannot be controlled by the operator is dangerous and needs to be repaired.

c) Disconnect the plug from the power source and / or the battery pack from the front tool any adjustment, change of accessories or before storing the tool. These preventive safety measures reduce the risk of accidental starting of the tool.

d) Keep tools at a standstill out of the reach of children and do not allow unauthorized persons not knowing the tool or these instructions to operate it. Tools are dangerous in the hands of novice users.

e) Observe the maintenance of the tool. Check that there is no misalignment or blockage of the moving parts, broken parts or any other condition that may affect the operation of the tool. If damaged, have the tool repaired before using it. Many accidents are due to poorly maintained tools.

f) Keep cutting tools affinities and clean. Properly maintained cutting tools with sharp cut pieces are less likely to jam and are easier to control.

g) Use the tool, accessories and blades etc., in accordance with these instructions, taking into account working conditions and the work to be done. The use of the tool for different operations planned attacks could give rise to dangerous situations.

6. Maintenance and care

a) Have it checked by a qualified repairer using only identical spare parts. This will ensure that the safety of the tool is maintained.

7. Explore view and spare parts list

Spare parts list					
No.	NAME	QTY	NO.	NAME	QTY
1	sandpaper	1	46	right Connection block	1
2	adhibit tray	1	47	left Connection block	1
3	wool mat	1	48	cross-flat screw ST4X20	2
4	snap-ring ϕ 40	1	49	cross-flat screw ST4X25	2
5	plastic disc	1	50	left handle	1
6	spring ϕ 2X ϕ 45X ϕ 49X40X4	1	51	cable cover	1
7	circlip-internal ϕ 32	1	52	cable (plug)	1
8	ball-bearing 6002 2RS	1	53	handle's screw	1
9	connecting spindle	1	54	aluminum pipe	1
10	pivot hub	1	55	left Clamping block	1
11	hex screw M6X20	2	56	right Clamping block	1
12	support arm	1	57	LC	1set
13	O-ring 2.75X15	1	58	variable speed control	1
14A	drive shaft cover	1	59	right handle	1
14B	drive shaft	1	60	switch	1
15	dust shroud	1	61	cable	1
16	cross-flat screw M4x12	2	62	cable clip	1
17	flexible pad ϕ 4	2	63	cross-flat screw ST4X12	2
18	hex screw M6X20	2	64	hose clamp ϕ 25-38	1
19	string board	1	65	soft pipe	1
20	sharp-cross screw ST4X45	4	66	left fork arm	1
21	gear box	1	67	right fork arm	1
22	spindle	1	68	hex screw M5X12	4
23	ball-bearing 6001 2RS	1	69	cross-flat screw ST4X18	2
24	circlip-internal ϕ 12	1	70	cross-flat screw ST4X20	3
25	circlip-external ϕ 28	1	71	big aluminum pipe(front)	1
26	big gear M1X32T	1	72	cross-flat screw ST4X20	11
27	ball bearing 698ZZ	1	73	cross-flat screw ST4X18	2
28A	needle bearing HK0810(ϕ 8X ϕ 12X10)	1	74	cross-flat screw ST4X14	3
28B	flat washer ϕ 8X1	1	75	circlip-internal ϕ 10	1
29	intermediate spindle M1X11T	1	76	grease holder	2
30	parallel key 4X4X6	2	77	cross-flat screw	6
31	input gear M0.8X35T	1	78	nylon brush/skirt	1
32	ball bearing 608ZZ	1	accessories		
33	gear plate	1	1	soft pipe	1
34	ball bearing 6000 2RS	1	2	adaptor	2个

35	rotator	1	3	Y-shape spanner 7mm	1
36	sealing ring	1	4	hex spanner	1
37	ball bearing 607 2RS	1	5	2-dual spanner	1
38	bearing cover (607) Φ22.1XΦ19X9	1	6	cable clip	6
39	sealing ring	1	7	carbon brush	1set
40	cross-flat screw ST4X50	2	Bail Handle		
41	stator	1	1	bail handle	1
42	motor housing	1	2	hex spanner	1
43	carbon brush cover	2			
44	carbon brush TY388, 5X8X12	2			
45	carbon brush holder	2			

DMJ-700B-1

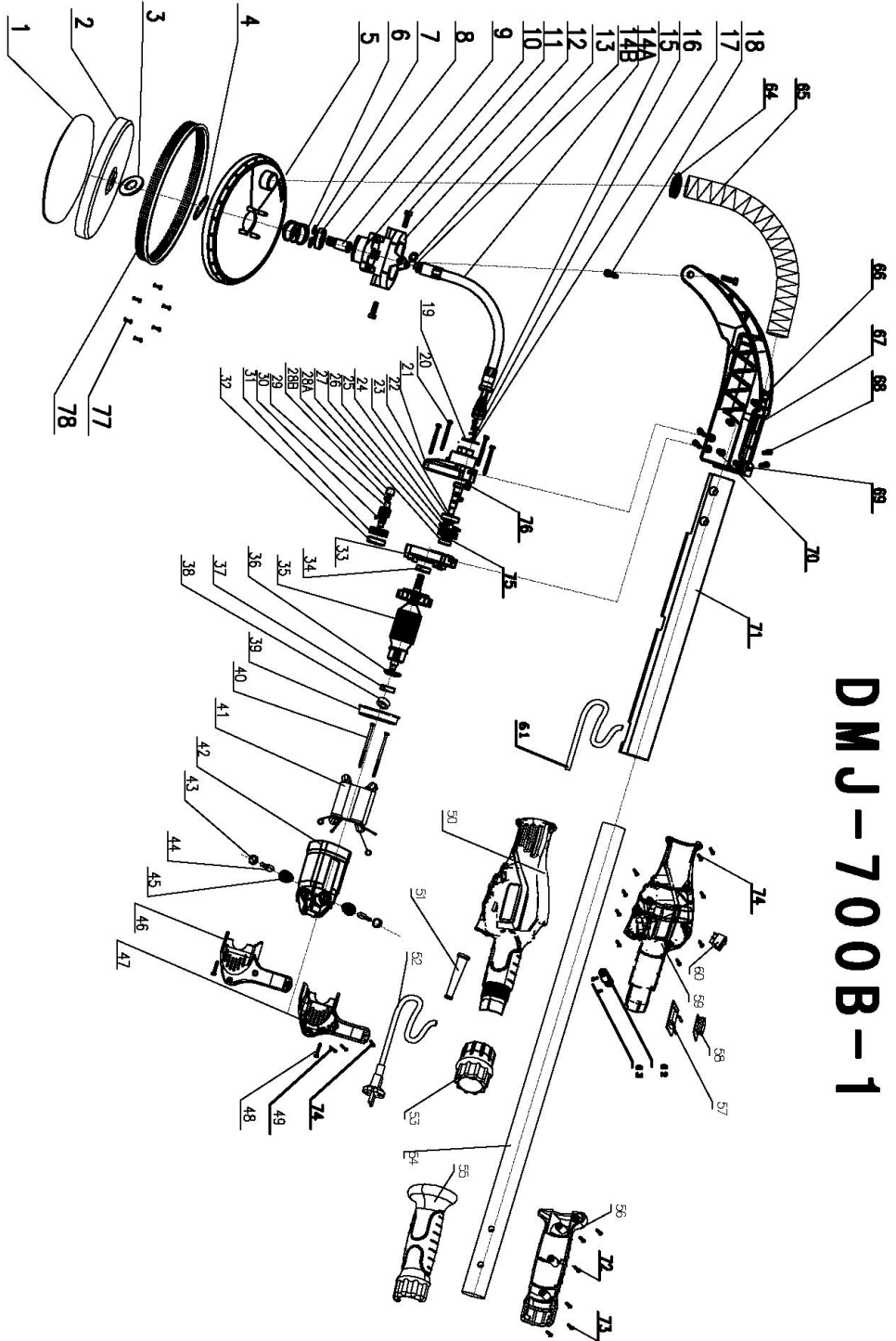

8. DECLARATION OF CONFORMITY



BUILDER SAS

ZI - 32 rue Aristide Bergès - 31270 Cugnaux - France

Tel: +33 (0)5.34.502.502 Fax: +33 (0)5.34.502.503

States that the designated below machine

DRYWALL SANDER

Model: FPG710-SH

Serial number: 20210507381-20210507680

Has been developed, designed and manufactured in accordance with the requirements of directives:

Machinery Directive 2006/42/EC,

EMC Directive 2014/30/EC

RoHS Directive (EU)2015/863 amending 2011/65/EU

And also meets the following standards:

EN60745-1:2009/A11:2010

EN60745-2-3:2011/A13:2015

EN55014-1:2017

EN55014-2:2015

EN61000-3-2:2014

EN61000-3-3:2013

Date: 03-03-2021

A handwritten signature in black ink, appearing to read 'Philippe MARIE', is located below the date.

Philippe MARIE/PDG

9. WARRANTY



WARRANTY

The manufacturer guarantees the product against defects in material and workmanship for a period of 2 years from the date of the original purchase. The warranty only applies if the product is for household use. The warranty does not cover breakdowns due to normal wear and tear.

The manufacturer agrees to replace parts identified as defective by the designated distributor. The manufacturer does not accept responsibility for the replacement of the machine, in whole or in part, and/or ensuing damage.

The warranty does not cover breakdowns due to:

- insufficient maintenance.
- abnormal assembly, adjustment or operations of the product.
- parts subject to normal wear and tear.

The warranty does not extend to:

- shipping and packaging costs.
- using the tool for a purpose other than that for which it was designed.
- the use and maintenance of the machine done in a manner not described in the user manual.

Due to our policy of continuous product improvement, we reserve the right to alter or change specifications without notice. Consequently, the product may be different from the information contained therein, but a modification will be undertaken without notice if it is recognized as an improvement of the preceding characteristic.

READ THE MANUAL CAREFULLY BEFORE USING THE MACHINE.

When ordering spare parts, please indicate the part number or code, you can find this in the spare parts list in this manual. Keep the purchase receipt; without it, the warranty is invalid. To help you with your product, we invite you to contact us by phone or via our website:

- **+33 (0)9.70.75.30.30**
- **<https://services.swap-europe.com/contact>**

You must create a "ticket" via the web platform.

- Register or create your account.
- Indicate the reference of the tool.
- Choose the subject of your request.
- Describe your problem.
- Attach these files: invoice or sales receipt, photo of the identification plate (serial number), photo of the part you need (for example: pins on the transformer plug which are broken).



10. PRODUCT FAILURE

WHAT TO DO IF MY MACHINE BREAKS DOWN?

If you bought your product in a store:

- a) Empty the fuel tank.
- b) Make sure that your machine is complete with all accessories supplied, and clean! If this is not the case, the repairer will refuse the machine.

Go to the store with the complete machine and with the receipt or invoice.

If you bought your product on a website:

- a) Empty the fuel tank.
- b) Make sure that your machine is complete with all accessories supplied, and clean! If this is not the case, the repairer will refuse the machine.
- c) Create a SWAP-Europe service ticket on the site: <https://services.swap-europe.com> When making the request on SWAP-Europe, you must attach the invoice and the photo of the nameplate (serial number).
- d) Contact the repair station to make sure it is available before dropping off the machine.

Go to the repair station with the complete machine packed, accompanied by the purchase invoice and the station support sheet downloadable after the service request is completed on the SWAP-Europe site

For machines with engine failure from manufacturers BRIGGS & STRATTON, HONDA and RATO, please refer to the following instructions.

Repairs will be done by approved engine manufacturers of these manufacturers, see their site:

- <http://www.briggsandstratton.com/eu/fr>
- <http://www.honda-engines-eu.com/fr/service-network-page;jsessionid=5EE8456CF39CD572AA2AEEDFD290CDAE>
- <https://www.rato-europe.com/it/service-network>

Please keep your original packaging to allow for after-sales service returns or pack your machine with a similar cardboard box of the same dimensions.

For any question concerning our after-sales service you can make a request on our website <https://services.swap-europe.com>

Our hotline remains available at +33 (9) 70 75 30 30.



11. WARRANTY EXCLUSIONS

THE WARRANTY DOES NOT COVER:

- Start-up and setting up of the product.
- Damage resulting from normal wear and tear of the product.
- Damage resulting from improper use of the product.
- Damage resulting from assembly or start-up not in accordance with the user manual.
- Breakdowns related to carburetion beyond 90 days and fouling of carburetors.
- Periodic and standard maintenance events.
- Actions of modification and dismantling that directly void the warranty.
- Products whose original authentication marking (brand, serial number) has been degraded, altered or withdrawn.
- Replacement of consumables.
- The use of non-original parts.
- Breakage of parts following impacts or projections.
- Accessories breakdowns.
- Defects and their consequences linked to any external cause.
- Loss of components and loss due to insufficient screwing.
- Cutting components and any damage related to the loosening of parts.
- Overload or overheating.
- Poor power supply quality: faulty voltage, voltage error, etc.
- Damages resulting from the deprivation of enjoyment of the product during the time necessary for repairs and more generally the costs related to the immobilization of the product.
- The costs of a second opinion established by a third party following an estimate by a SWAP-Europe repair station
- The use of a product which would show a defect or a breakage which was not the subject of an immediate report and/or repair with the services of SWAP-Europe.
- Deterioration linked to transport and storage*.
- Launchers beyond 90 days.
- Oil, petrol, grease.
- Damages related to the use of non-compliant fuels or lubricants.

* In accordance with transport legislation, damage related to transport must be declared to carriers within 48 hours maximum after observation by registered letter with acknowledgement of receipt.

This document is a supplement to your notice, a non-exhaustive list.

Attention: all orders must be checked in the presence of the delivery person. In case of refusal by the delivery person, it you must simply refuse the delivery and notify your refusal.

Reminder: the reserves do not exclude the notification by registered letter with acknowledgement within 72 hours.

Information:

Thermal devices must be wintered each season (service available on the SWAP-Europe site). Batteries must be charged before being stored.